

Single-Phase, Integrated Heatsink Type SSR

SRH1 Series

[Top-Bottom Terminal]

Single-Phase, Integrated Heatsink Type SSR [Top-Bottom Terminal]

■ Features

- High heat dissipation efficiency with ceramic PCB and integrated heatsink
- Input Indicator (green LED)
- DIN rail mount or panel mount installation
- [Voltage input type]
Zero cross turn-on, random turn-on models available
- [Current input type]
Phase control and cycle control possible
 - Phase control (power equality division/phase equality division)
 - Cycle control (fixed cycle/variable cycle)

⚠ Please read "Safety considerations" in operation manual before using.



Line-up

[Voltage input type]



Rated load current

10A/15A/20A

30A/40A

60A

[Current input type]



Rated load current

20A/30A

60A

■ Ordering Information

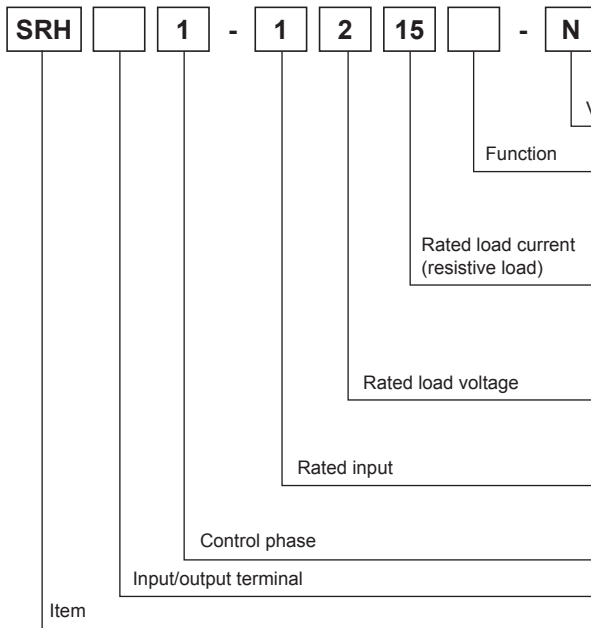

| | Voltage input type | Current input type |
|-------------------------------------|--|--------------------|
| Version | N Renewal | |
| Function | No Mark Zero cross turn-on | — |
| | R Random turn-on | — |
| Rated load current (resistive load) | 10 10A | — |
| | 15 15A | — |
| | 20 20A | 20A |
| | 30 30A | 30A |
| | 40 40A | — |
| | 60 60A | 60A |
| Rated load voltage | 2 24-240VAC | 100-240VAC |
| | 4 48-480VAC | 200-480VAC |
| Rated input | 1 4-30VDC | — |
| | 2 24VAC | — |
| | 4 90-240VAC | — |
| Control phase | A — | 4-20mA |
| Input/output terminal | 1 Single-phase | — |
| | No Mark Top-Bottom terminal | — |
| Item | SRH Solid State Relay (integrated heatsink type) | — |

※ This ordering information is only for reference. For ordering a specific model, check the ordering information of the model.

※ For more information about models, refer to the [B-16 page for the voltage input type] [B-22 page for the current input type]

- (A) Photoelectric Sensors
- (B) Fiber Optic Sensors
- (C) Door/Area Sensors
- (D) Proximity Sensors
- (E) Pressure Sensors
- (F) Rotary Encoders
- (G) Connectors/ Connector Cables/ Sensor Distribution Boxes/Sockets
- (H) Temperature Controllers
- (I) SSRs / Power Controllers
- (J) Counters
- (K) Timers
- (L) Panel Meters
- (M) Tacho / Speed / Pulse Meters
- (N) Display Units
- (O) Sensor Controllers
- (P) Switching Mode Power Supplies
- (Q) Stepper Motors & Drivers & Controllers
- (R) Graphic/ Logic Panels
- (S) Field Network Devices
- (T) Software

SRH1 Series

Single-Phase, Integrated Heatsink Type SSR [Voltage Input Type]

■ Model

| Model | Rated input voltage | Rated load voltage | Rated input current | Function |
|--------------|---------------------|--------------------|---------------------|--------------------|
| SRH1-1210-N | 4-30VDC | 10A | 24-240VAC | Zero cross turn-on |
| SRH1-2210-N | 24VAC | | | |
| SRH1-4210-N | 90-240VAC | | | |
| SRH1-1215-N | 4-30VDC | 15A | | |
| SRH1-2215-N | 24VAC | | | |
| SRH1-4215-N | 90-240VAC | | | |
| SRH1-1220-N | 4-30VDC | 20A | | |
| SRH1-2220-N | 24VAC | | | |
| SRH1-4220-N | 90-240VAC | | | |
| SRH1-1230-N | 4-30VDC | 30A | | |
| SRH1-2230-N | 24VAC | | | |
| SRH1-4230-N | 90-240VAC | | | |
| SRH1-1240-N | 4-30VDC | 40A | | |
| SRH1-2240-N | 24VAC | | | |
| SRH1-4240-N | 90-240VAC | | | |
| SRH1-1260-N | 4-30VDC | 60A | | |
| SRH1-2260-N | 24VAC | | | |
| SRH1-4260-N | 90-240VAC | | | |
| SRH1-1410-N | 4-30VDC | 10A | 48-480VAC | Zero cross turn-on |
| SRH1-1410R-N | 4-30VDC | | | Random turn-on |
| SRH1-2410-N | 24VAC | | | Zero cross turn-on |
| SRH1-1415-N | 4-30VDC | 15A | | Zero cross turn-on |
| SRH1-1415R-N | | | | Random turn-on |
| SRH1-2415-N | | | | 24VAC |
| SRH1-1420-N | 4-30VDC | 20A | | Zero cross turn-on |
| SRH1-1420R-N | | | | Random turn-on |
| SRH1-2420-N | | | | 24VAC |
| SRH1-1430-N | 4-30VDC | 30A | | Zero cross turn-on |
| SRH1-1430R-N | | | | Random turn-on |
| SRH1-2430-N | | | | 24VAC |
| SRH1-1440-N | 4-30VDC | 40A | Zero cross turn-on | |
| SRH1-1440R-N | | | Random turn-on | |
| SRH1-2440-N | | | 24VAC | Zero cross turn-on |
| SRH1-1460-N | 4-30VDC | 60A | Zero cross turn-on | |
| SRH1-1460R-N | | | Random turn-on | |
| SRH1-2460-N | | | 24VAC | Zero cross turn-on |

■ Specifications

◎ Input

| | | | |
|-------------------------------|--------------------|-------------------------------------|-----------------------------------|
| Rated input voltage range | 4-30VDC≡ | 24VACrms~ (50/60Hz) | 90-240VACrms~ (50/60Hz) |
| Allowable input voltage range | 4-32VDC≡ | 19-30VACrms~ (50/60Hz) | 85-264VACrms~ (50/60Hz) |
| Max. input current | 18mA | 15mA _{rms} (24VACrms~) | 18mA _{rms} (240VACrms~) |
| Pick-up voltage | Min. 4VDC≡ | Min. 19VACrms~ | Min. 85VACrms~ |
| Drop-out voltage | Max. 1VDC≡ | Max. 4VACrms~ | Max. 10VACrms~ |
| Turn-on time | Zero cross turn-on | Max. 0.5 cycle of load source + 1ms | Max. 2 cycle of load source + 1ms |
| | Random turn-on | Max. 1ms | — |
| Turn-off time | | Max. 0.5 cycle of load source + 1ms | Max. 2 cycle of load source + 1ms |



Single-Phase, Integrated Heatsink Type SSR [Voltage Input Type]

○ Output

| | | | | | | | |
|---|--------------------------------------|--|---------------------|---------------------|----------------------|----------------------|----------------------|
| Rated load voltage range | 24-240VACrms ~ (50/60Hz) | | | | | | |
| Allowable load voltage range | 24-264VACrms ~ (50/60Hz) | | | | | | |
| Rated load current | Resistive load (AC-51) ^{※1} | 10Arms | 15Arms | 20Arms | 30Arms | 40Arms | 60Arms |
| Min. load current | | 0.15Arms | 0.15Arms | 0.2Arms | 0.5Arms | 0.5Arms | 0.5Arms |
| Max. 1 cycle surge current (60Hz) | | 160A | 160A | 250A | 400A | 500A | 1000A |
| Max. non-repetitive surge current (I ² t, t=8.3ms) | | 130A ² s | 130A ² s | 300A ² s | 910A ² s | 1000A ² s | 4000A ² s |
| Peak voltage (non-repetitive) | | 600V | | | | | |
| Leakage current (Ta=25°C) | | Max. 10mArms (240VAC~/60Hz) | | | | | |
| Output on voltage drop [Vpk] (max. load current) | | Max. 1.6V | | | | | |
| Static off state dv/dt | | 500V/μs | | | | | |
| Rated load voltage range | 48-480VACrms ~ (50/60Hz) | | | | | | |
| Allowable load voltage range | 48-528VACrms ~ (50/60Hz) | | | | | | |
| Rated load current | Resistive load (AC-51) ^{※1} | 10Arms | 15Arms | 20Arms | 30Arms | 40Arms | 60Arms |
| Min. load current | | 0.5Arms | 0.5Arms | 0.5Arms | 0.5Arms | 0.5Arms | 0.5Arms |
| Max. 1 cycle surge current (60Hz) | | 300A | 300A | 300A | 500A | 500A | 1000A |
| Max. non-repetitive surge current (I ² t, t=8.3ms) | | 350A ² s | 350A ² s | 350A ² s | 1000A ² s | 1000A ² s | 4000A ² s |
| Peak voltage (non-repetitive) | | 1200V (zero cross turn-on), 1000V (random turn-on) | | | | | |
| Leakage current (Ta=25°C) | | Max. 10mArms (480VAC~/60Hz) | | | | | |
| Output on voltage drop [Vpk] (max. load current) | | Max. 1.6V | | | | | |
| Static off state dv/dt | | 500V/μs | | | | | |

※1: AC-51 is utilization category at IEC60947-4-3.

○ General specifications

| | | |
|------------------------------|---|---|
| Dielectric strength (Vrms) | 2500VAC 50/60Hz 1 min (input-output, input/output-case) | |
| Insulation resistance | Over 100MΩ (at 500VDC megger) (input-output, input/output-case) | |
| Indicator | Input indicator: green LED | |
| Vibration | Mechanical | 0.75mm amplitude at frequency of 10 to 55Hz (for 1 min) in each X, Y, Z direction for 1 hour |
| | Malfunction | 0.5mm amplitude at frequency of 10 to 55Hz (for 1 min) in each X, Y, Z direction for 10 min |
| Shock | Mechanical | 300m/s ² (approx. 30G) in each X, Y, Z direction for 3 times |
| | Malfunction | 100m/s ² (approx. 30G) in each X, Y, Z direction for 3 times |
| Environment | Ambient temp. | -30 to 80°C (in case of the rated input voltage 90-240VAC~: -20 to 70°C), storage: -30 to 100°C (The rated load current capacity is different depending on ambient temperature. Refer to '■ SSR Derating Curve'.) |
| | Ambient humi. | 45 to 85%RH, storage: 45 to 85%RH |
| Input terminal connection | Min. 1×0.5mm ² (1×AWG20), max. 1×1.5mm ² (1×AWG16) or 2×1.5mm ² (2×AWG16) | |
| Output terminal connection | <ul style="list-style-type: none"> Rated load current 10A/15A/20A : Min. 1×0.75mm² (1×AWG18), max. 1×4mm² (1×AWG12) or 2×2.5mm² (2×AWG14) Rated load current 30A/40A/60A : Min. 1×1.5mm² (1×AWG16), max. 1×16mm² (1×AWG6) or 2×6mm² (2×AWG10) ※Use wires compliant with load current capacity to connect to the terminal. | |
| Input terminal fixed torque | 0.75 to 0.95N·m | |
| Output terminal fixed torque | <ul style="list-style-type: none"> Rated load current 10A/15A/20A: 1.0 to 1.35N·m Rated load current 30A/40A/60A: 1.6 to 2.2N·m | |
| Approval |    | |
| Weight ^{※1} | <ul style="list-style-type: none"> Rated load current 10A/15A/20A: approx. 298g (approx. 225g) Rated load current 30A/40A: approx. 500g (approx. 410g) Rated load current 60A: approx. 770g (approx. 680g) | |

※1: The weight includes packaging. The weight in parenthesis is for unit only.

※Environment resistance is rated at no freezing or condensation.

※For wiring the terminal, round terminal must be used.

(A) Photoelectric Sensors

(B) Fiber Optic Sensors

(C) Door/Area Sensors

(D) Proximity Sensors

(E) Pressure Sensors

(F) Rotary Encoders

(G) Connectors/ Connector Cables/ Sensor Distribution Boxes/Sockets

(H) Temperature Controllers

(I) SSRs / Power Controllers

(J) Counters

(K) Timers

(L) Panel Meters

(M) Tacho / Speed / Pulse Meters

(N) Display Units

(O) Sensor Controllers

(P) Switching Mode Power Supplies

(Q) Stepper Motors & Drivers & Controllers

(R) Graphic/ Logic Panels

(S) Field Network Devices

(T) Software

SRH1 Series

■ Dimensions

● Rated load current 10A/15A/20A

● Rated load current 30A/40A

(unit: mm)

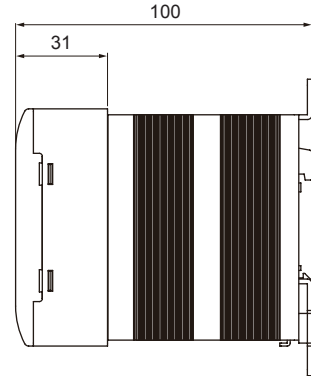
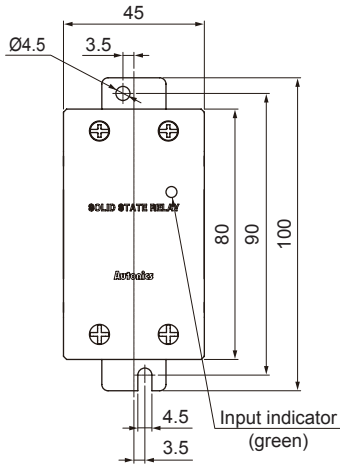
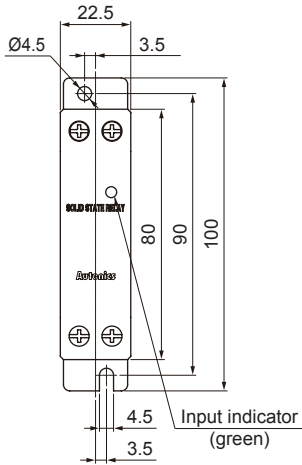

● Rated load current 60A

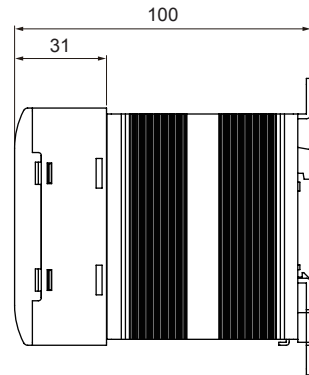
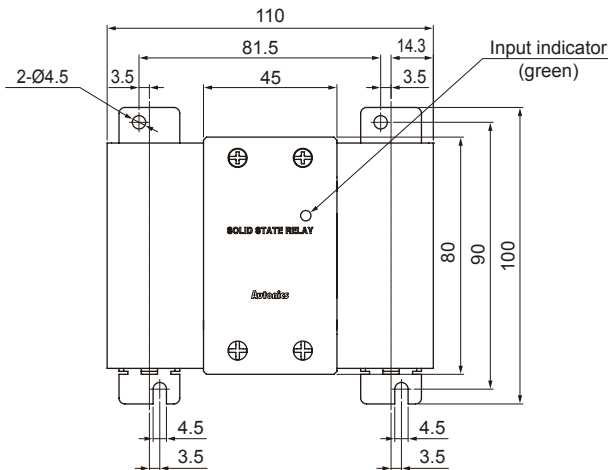

○ Panel cut-out

● Rated load current 10A/15A/20A/30A/40A

● Rated load current 60A

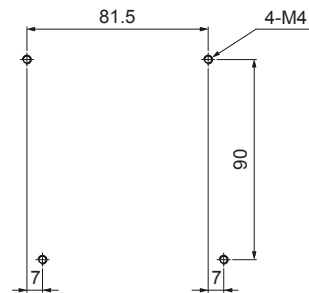
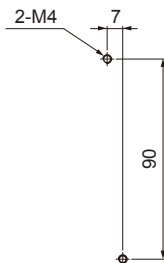

※Screw tightening torque for mounting: 1.8 to 2.5N·m

Single-Phase, Integrated Heatsink Type SSR [Voltage Input Type]

(unit: mm)

○ DIN rail mounting

● DIN rail attachment

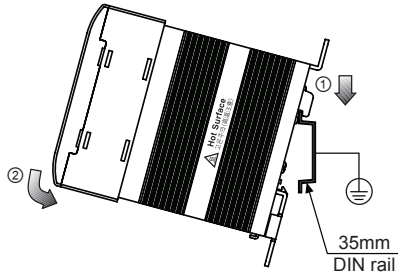

※DIN rail must be grounded.

● DIN rail detachment

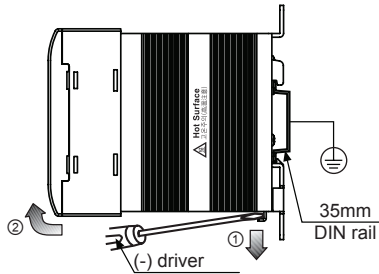

○ Spacing

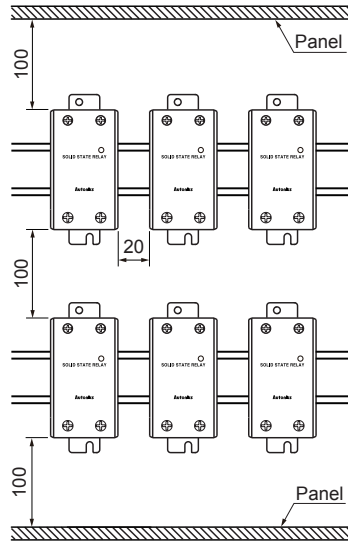

※When installing multiple SSRs, please keep space between SSRs for heat radiation. When installing SSRs horizontally (input part and output part on the same height), please supply less than 50% of the rated load current.



High temperature caution

While supplying power to the load or right after turning off the power of the load, do not touch the body and heat sink. Failure to follow this instruction may result in a burn due to the high temperature.

■ Connections

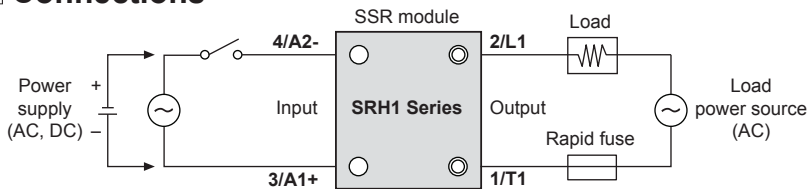

※Use terminals of size specified below.

| Terminal type | Input | Output | |
|--------------------|------------------------------|---------------|---------------|
| Rated load current | 10A, 15A, 20A, 30A, 40A, 60A | 10A, 15A, 20A | 30A, 40A, 60A |
| <Round> | a | Min. 3.5mm | Min. 4.0mm |
| | b | Max. 7.0mm | Max. 9.0mm |

| | |
|-----|--|
| (A) | Photoelectric Sensors |
| (B) | Fiber Optic Sensors |
| (C) | Door/Area Sensors |
| (D) | Proximity Sensors |
| (E) | Pressure Sensors |
| (F) | Rotary Encoders |
| (G) | Connectors/ Connector Cables/ Sensor Distribution Boxes/Sockets |
| (H) | Temperature Controllers |
| (I) | SSRs / Power Controllers |
| (J) | Counters |
| (K) | Timers |
| (L) | Panel Meters |
| (M) | Tacho / Speed / Pulse Meters |
| (N) | Display Units |
| (O) | Sensor Controllers |
| (P) | Switching Mode Power Supplies |
| (Q) | Stepper Motors & Drivers & Controllers |
| (R) | Graphic/ Logic Panels |
| (S) | Field Network Devices |
| (T) | Software |

SRH1 Series

■ SSR Derating Curve

◎ SRH1-1210/2210/4210-N

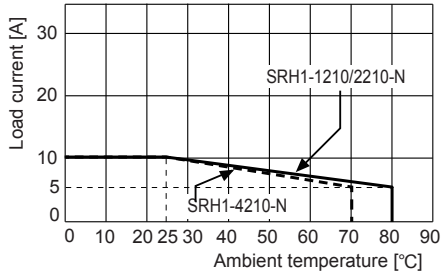

◎ SRH1-1410/1410R/2410-N

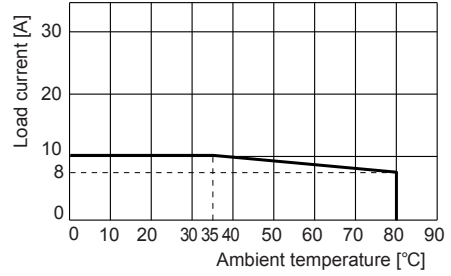

◎ SRH1-1215/2215/4215-N

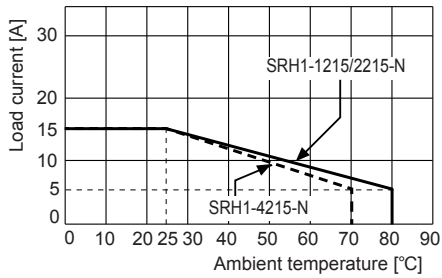

◎ SRH1-1415/1415R/2415-N

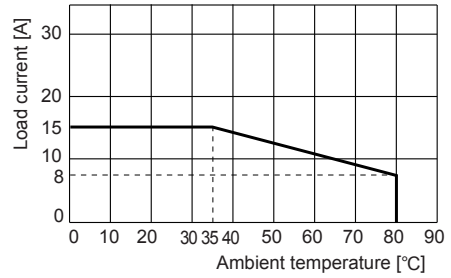

◎ SRH1-1220/2220/4220-N

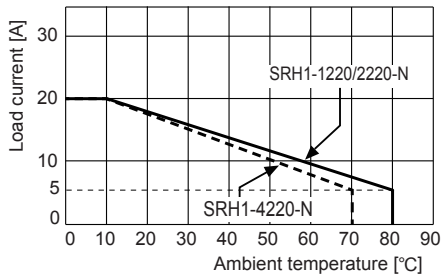

◎ SRH1-1420/1420R/2420-N

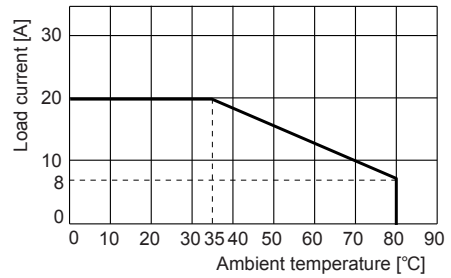

◎ SRH1-1230/2230/4230-N

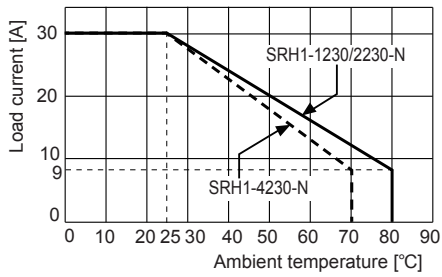

◎ SRH1-1430/1430R/2430-N

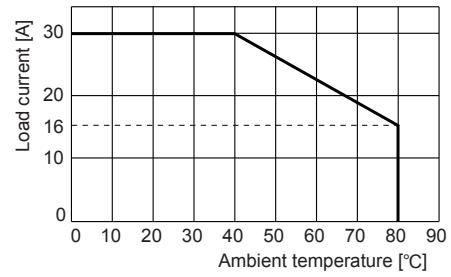

Single-Phase, Integrated Heatsink Type SSR [Voltage Input Type]

◎ SRH1-1240/2240/4240-N

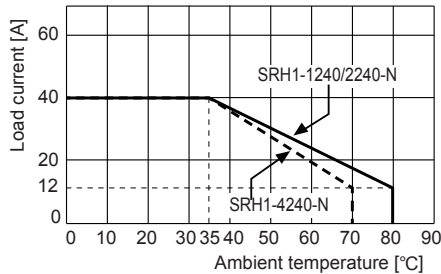

◎ SRH1-1440/1440R/2440-N

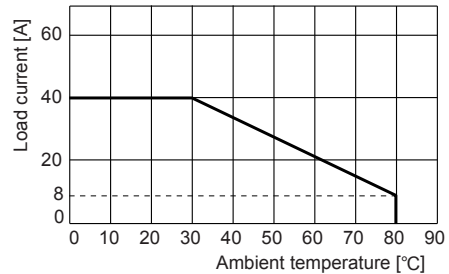

◎ SRH1-1260/1460/1460R-N SRH1-2260/2460/4260-N

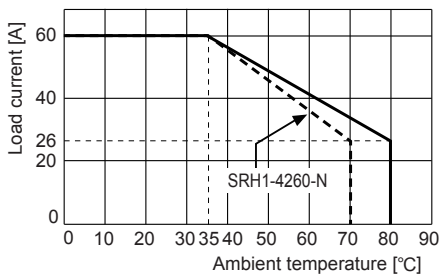

△ Since effectiveness of the heat radiation is decreased when multiple SSRs are installed closely, please supply less than 50% of the rated load current.

✕ Above SSR derating curves obtained approval from the UL certification authority.

■ Proper Usage

⚠ Cautions during use

- Follow instructions in 'Cautions during Use'. Otherwise, it may cause unexpected accidents.
- 4-30VDC, 24VAC signal input should be insulated and limited voltage/current or Class 2, SELV power supply device.
- Install the unit in the well ventilated place.
- Ground to the heat sink, panel, or DIN rail. Failure to follow this instruction may result in electric shock.
- Ground to the panel. Failure to follow this instruction may result in electric shock.
- While supplying power to the load or right after turning off the power of the load, do not touch the body and heat sink. Failure to follow this instruction may result in a burn due to the high temperature.
- In order to protect the product from the short-circuit current of the load, use rapid fuse of which I^2t is under the 1/2 of SSR I^2t . When short-circuited, replace the fuse to those of same specification with the used rapid fuse.
- Install dummy resistance in parallel with the load, to keep the sum of current flowing in the load and dummy resistance being over SSR minimum load current.
- When using random turn-on model for phase control, install noise filter between the load and the power of the load.
- Do not use near the equipment which generates strong magnetic force or high frequency noise.
- This unit may be used in the following environments.
 - Indoors (in the environment condition rated in 'Specifications')
 - Altitude max. 2,000m
 - Pollution degree 2
 - Installation category III

(A) Photoelectric Sensors

(B) Fiber Optic Sensors

(C) Door/Area Sensors

(D) Proximity Sensors

(E) Pressure Sensors

(F) Rotary Encoders

(G) Connectors/ Connector Cables/ Sensor Distribution Boxes/Sockets

(H) Temperature Controllers

(I) SSRs / Power Controllers

(J) Counters

(K) Timers

(L) Panel Meters

(M) Tacho / Speed / Pulse Meters

(N) Display Units

(O) Sensor Controllers

(P) Switching Mode Power Supplies

(Q) Stepper Motors & Drivers & Controllers

(R) Graphic/ Logic Panels

(S) Field Network Devices

(T) Software

SRH1 Series

Single-Phase, Integrated Heatsink Type SSR [Current Input Type]

■ Model

| Model | Rated input current | Rated load current | Rated load voltage | Model | Rated input current | Rated load current | Rated load voltage |
|-------------|---------------------|--------------------|--------------------|-------------|---------------------|--------------------|--------------------|
| SRH1-A220-N | 4-20mA | 20A | 100-240VAC | SRH1-A420-N | 4-20mA | 20A | 200-480VAC |
| SRH1-A230-N | | 30A | | SRH1-A430-N | | 30A | |
| SRH1-A260-N | | 60A | | SRH1-A460-N | | 60A | |

■ Specifications

○ Input

| | |
|------------------------------|---|
| Rated input current | 4-20mA |
| Max. allowable input current | 50mA |
| Pick-up current | Min. 4.2mA |
| Static off current | Max. 4.0mA |
| Power factor | Min. 0.9 (max. 25° of difference between voltage phase and current phase) |
| Start-up time | 60Hz: 200ms, 50Hz: 250ms |
| Operation time | 60Hz: 16.6ms, 50Hz: 20ms |
| Operation mode ^{※1} | Phase control (phase equality division type, power equality division type) Cycle control (fixed cycle, variable cycle) |

※1: You can change operation mode by jumper pin. Default is Phase control (Power equality division type).

○ Output

| Rated load voltage range | 100-240VACrms ~ (50/60Hz) | | | 200-480VACrms ~ (50/60Hz) | | |
|---|-----------------------------|----------------------|----------------------|-----------------------------|----------------------|----------------------|
| Allowable load voltage range | 90-264VACrms ~ (50/60Hz) | | | 200-528VACrms ~ (50/60Hz) | | |
| Rated load current | 20Arms | 30Arms | 60Arms | 20Arms | 30Arms | 60Arms |
| Resistive load (AC-51) ^{※1} | | | | | | |
| Min. load current | 0.5Arms | | | 0.5Arms | | |
| Max. 1 cycle surge current (60Hz) | 300A | 500A | 1000A | 300A | 500A | 1000A |
| Max. non-repetitive surge current (I ² t, t=8.3ms) | 350A ² s | 1000A ² s | 4000A ² s | 350A ² s | 1000A ² s | 4000A ² s |
| Peak voltage (non-repetitive) | 600V | | | 1000V | | |
| Leakage current (Ta=25°C) | Max. 10mArms (240VAC~/60Hz) | | | Max. 10mArms (480VAC~/60Hz) | | |
| Output on voltage drop[Vpk] (Max. load current) | Max. 1.6V | | | | | |
| Static off-state dv/dt | 500V/μs | | | | | |

※1: AC-51 are utilization category at IEC60947-4-3.

○ General specifications

| | | |
|--|---|---|
| Phase control (phase equality division type) | 5 to 99% | |
| Phase control (power equality division type) | 10 to 99% | |
| Frequency reading function | Yes | |
| Dielectric strength (Vrms) | 4000VAC 50/60Hz for 1 min (input-output, input/output-case) | |
| Insulation resistance | Over 100MΩ (at 500VDC megger) | |
| Indicator | Input indicator: green LED | |
| Vibration | 0.75mm amplitude at frequency of 10 to 55Hz (for 1 min) in each X, Y, Z direction for 1 hour | |
| Environment | Ambient temp. | -20 to 70°C, storage: -20 to 100°C (The rated load current capacity is different depending on ambient temperature. Refer to '■ SSR Derating Curve'.) |
| | Ambient humi. | 45 to 85%RH, storage: 45 to 85%RH |
| Input terminal connection | Min. 1×0.5mm ² (1×AWG20), max. 1×16mm ² (1×AWG6) or 2×1.5mm ² (2×AWG16) | |
| Output terminal connection | Min. 1×1.5mm ² (1×AWG16), max. 1×16mm ² (1×AWG6) or 2×6mm ² (2×AWG10) ※Use wires compliant with load current capacity to connect to the terminal. | |
| Input terminal fixed torque | 0.75 to 0.95N·m | |
| Output terminal fixed torque | 1.6 to 2.2N·m | |
| Approval | CE  us | |
| Unit weight | • Rated load current 20A/30A: Approx. 410g • Rated load current 60A: Approx. 680g | |

※Environment resistance is rated at no freezing or condensation.

※For wiring the terminal, round terminal must be used.

Single-Phase, Integrated Heatsink Type SSR [Current Input Type]

(unit: mm)

■ Dimensions

● Rated load current 20A/30A

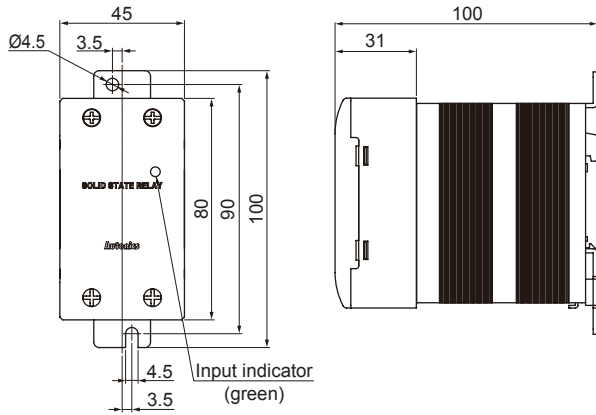

○ Panel cut-out

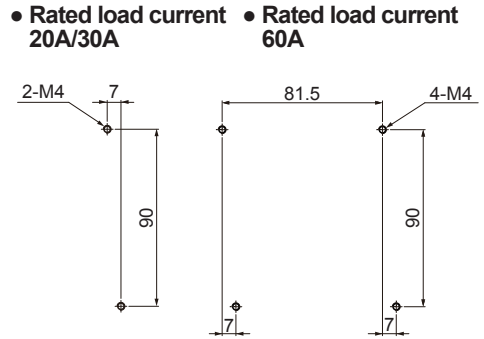

※Screw tightening torque for mounting: 1.8 to 2.5N·m

● Rated load current 60A

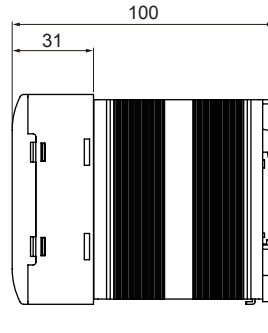
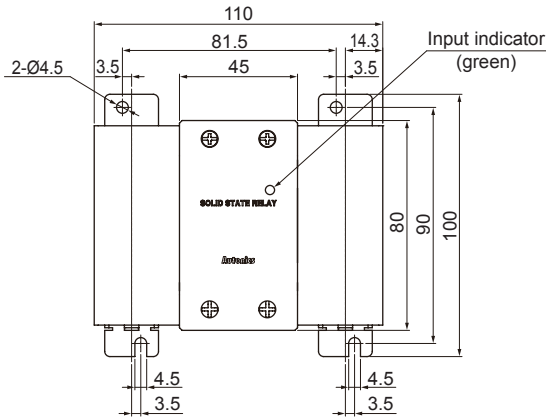

○ DIN rail mounting

● DIN rail attachment

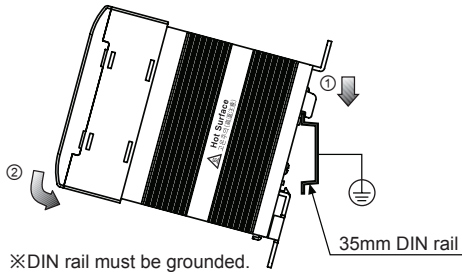

● DIN rail detachment

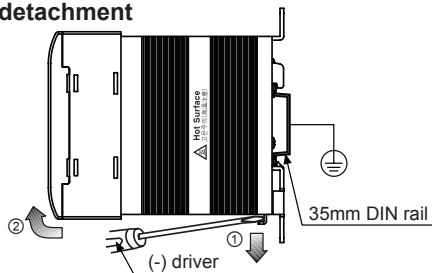

○ Spacing

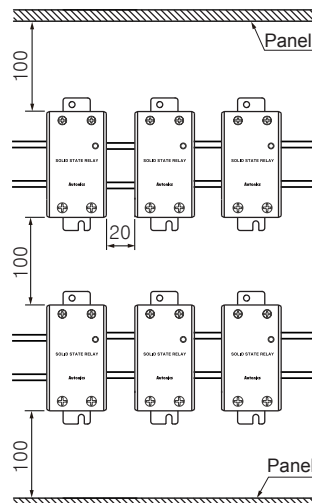

※When installing multiple SSRs, please keep space between SSRs for heat radiation. When installing SSRs horizontally (input part and output part on the same height), please supply less than 50% of the rated load current.

High temperature caution
While supplying power to the load or right after turning off the power of the load, do not touch the body and heat sink. Failure to follow this instruction may result in a burn due to the high temperature.

| | |
|-----|---|
| (A) | Photoelectric Sensors |
| (B) | Fiber Optic Sensors |
| (C) | Door/Area Sensors |
| (D) | Proximity Sensors |
| (E) | Pressure Sensors |
| (F) | Rotary Encoders |
| (G) | Connectors/ Connector Cables/ Sensor Distribution Boxes/Sockets |
| (H) | Temperature Controllers |
| (I) | SSRs / Power Controllers |
| (J) | Counters |
| (K) | Timers |
| (L) | Panel Meters |
| (M) | Tacho / Speed / Pulse Meters |
| (N) | Display Units |
| (O) | Sensor Controllers |
| (P) | Switching Mode Power Supplies |
| (Q) | Stepper Motors & Drivers & Controllers |
| (R) | Graphic/ Logic Panels |
| (S) | Field Network Devices |
| (T) | Software |

SRH1 Series

■ Connections

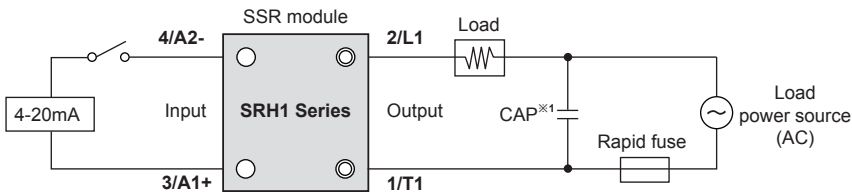

※1: When connecting noise filter and capacitor, it is appropriate for EMC.

CAP: Rated load voltage 100-240VAC → 1uF/250VAC
 Rated load voltage 200-480VAC → 0.47uF/500VAC

※Use terminals of size specified below.

| Terminal type | Input | Output |
|---------------|-------|-------------|
| <Round> | a | Min. 3.5mm |
| | b | Max. 7.0mm |
| | | Min. 5.0mm |
| | | Max. 12.0mm |

■ SSR Derating Curve

○ SRH1-A220/A420-N

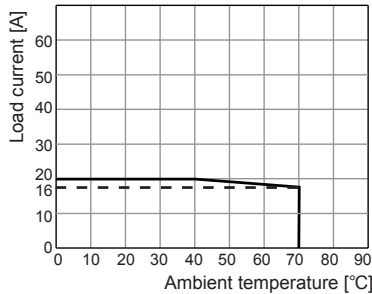

○ SRH1-A230/A430-N

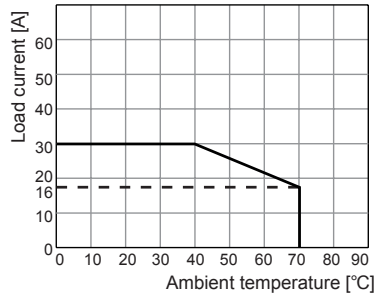

○ SRH1-A260/A460-N

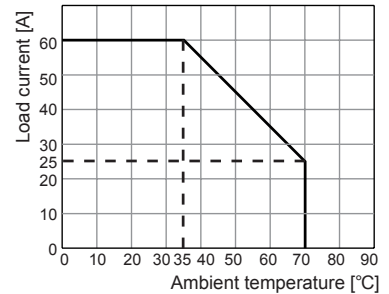

⚠ Since effectiveness of the heat radiation is decreased when multiple SSRs are installed closely, please supply less than 50% of the rated load current.

※Above SSR derating curves obtained approval from the UL certification authority.

■ Operation Setting

● Detach front cover

Press front cover connection 4 parts at right and left side with (-) driver, and front cover is detached.

※Before detaching front cover, you must cut off load current and input.

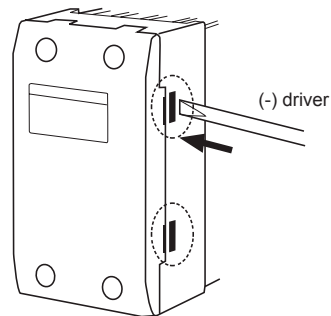

● Jumper pin setting

Operation mode is decided by jumper position.
 After changing operation mode, re-supply input signal.

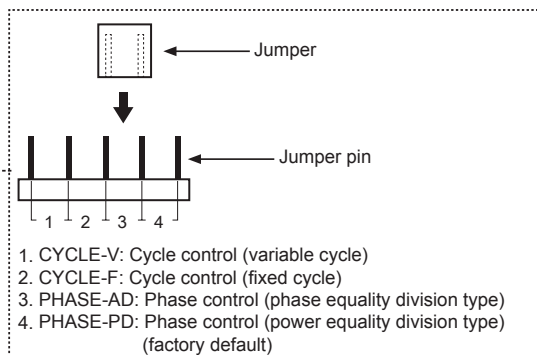
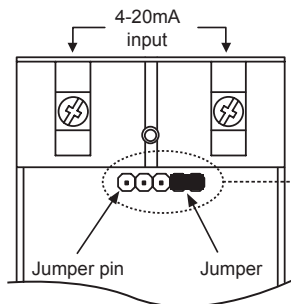

Single-Phase, Integrated Heatsink Type SSR [Current Input Type]

■ Operation Mode

○ Phase control

● Output waveform of phase control

- When control input signal is 25%
- When control input signal is 50%
- When control input signal is 75%

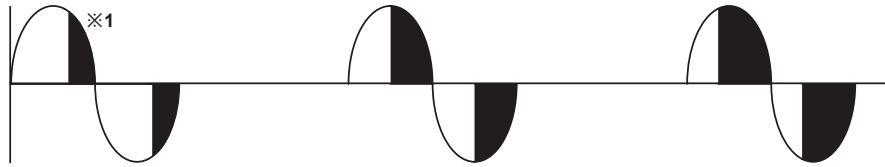

※1: The black parts of output waveform are output on the load.

● Power equality division type

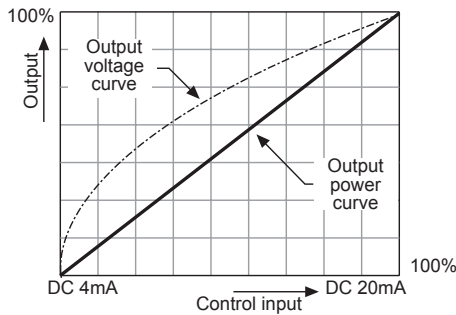

Controls output power which is proportional to control input (4-20mA) level.

● Phase equality division type

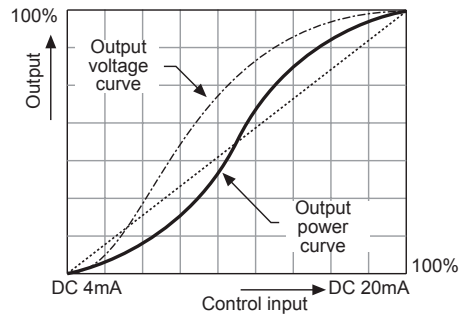

Controls phase angle which is proportional to control input (4-20mA) level.

○ Cycle control

● Fixed cycle

Controls continuously the number of full cycle which is supplied to load every 1 sec by being proportional to control input (4-20mA).

- When control input signal is 0%
- When control input signal is 50%
- When control input signal is 100%

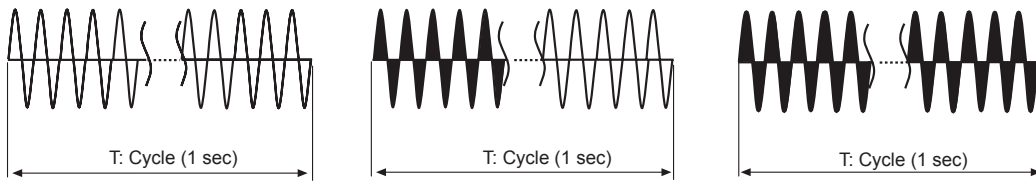

● Variable cycle

Controls fast and accurately the subject with optimized the number of AC voltage cycle which is supplied to load by being proportional to control input (4-20mA).

- When control input signal is 10%
- When control input signal is 50%
- When control input signal is 90%

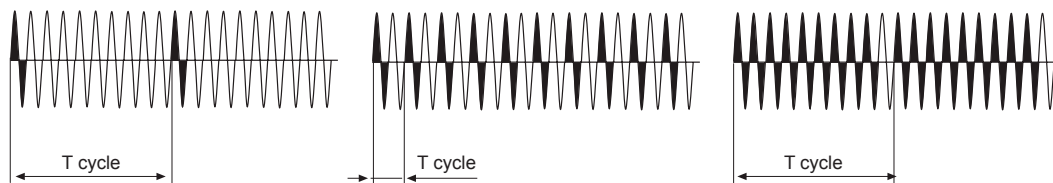

| | |
|-----|---|
| (A) | Photoelectric Sensors |
| (B) | Fiber Optic Sensors |
| (C) | Door/Area Sensors |
| (D) | Proximity Sensors |
| (E) | Pressure Sensors |
| (F) | Rotary Encoders |
| (G) | Connectors/ Connector Cables/ Sensor Distribution Boxes/Sockets |
| (H) | Temperature Controllers |
| (I) | SSRs / Power Controllers |
| (J) | Counters |
| (K) | Timers |
| (L) | Panel Meters |
| (M) | Tacho / Speed / Pulse Meters |
| (N) | Display Units |
| (O) | Sensor Controllers |
| (P) | Switching Mode Power Supplies |
| (Q) | Stepper Motors & Drivers & Controllers |
| (R) | Graphic/ Logic Panels |
| (S) | Field Network Devices |
| (T) | Software |

■ Proper Usage

⚠ Cautions during use

1. Follow instructions in 'Cautions during Use'. Otherwise, it may cause unexpected accidents.
2. Install the unit in the well ventilated place.
3. Ground to the heat sink, panel, or DIN rail. Failure to follow this instruction may result in electric shock.
4. While supplying power to the load or right after turning off the power of the load, do not touch the body and heat sink. Failure to follow this instruction may result in a burn due to the high temperature.
5. In order to protect the product from the short-circuit current of the load, use rapid fuse of which I^2t is under the 1/2 of SSR I^2t . When short-circuited, replace the fuse to those of same specification with the used rapid fuse.
6. Install dummy resistance in parallel with the load, to keep the sum of current flowing in the load and dummy resistance being over SSR minimum load current.
7. Do not use near the equipment which generates strong magnetic force or high frequency noise.
8. This unit may be used in the following environments.
 - ① Indoors (in the environment condition rated in 'Specifications')
 - ② Altitude max. 2,000m
 - ③ Pollution degree 2
 - ④ Installation category III